



# SAW Components

Data Sheet K 3350 K





**SAW Components**

**K 3350 K**

**IF Filter for Quasi/Split Sound Applications**

**38,90 MHz**

**Data Sheet**

**Standard**

- B/G
- D/K

**Features**

- TV IF filter for quasi/split sound applications (separate picture and sound channel)
- Picture channel with Nyquist slope and sound suppression
- Reduced group delay predistortion as compared with standard B/G half
- Sound channel with one passband for sound carriers at 32,40 MHz (D/K) and 33,40 MHz (B/G)
- Suitable for CENELEC EN 55020

Plastic package **DIP10K**

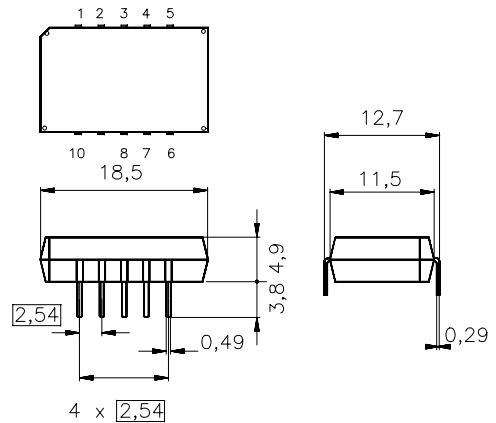

Dimensions in mm, approx. weight 1,8 g

**Terminals**

- Tinned CuFe alloy

**Pin configuration**

- 1 Input
- 2 Input - ground
- 3; 8 Chip carrier - ground
- 4; 5 Output - sound
- 6; 7 Output - picture
- 9 Free
- 10 Not connected

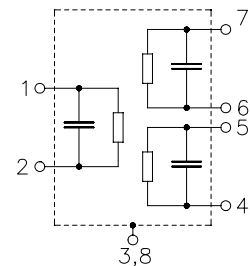

Type	Ordering code	Marking and package according to	Packing according to
K 3350 K	B39389-K3350-K100	C61157-A2-A3	F61074-V8068-Z000

**Maximum ratings**

Operable temperature range	$T_A$	-25/+65	°C	
Storage temperature range	$T_{stg}$	-40/+85	°C	
DC voltage	$V_{DC}$	5	V	between any terminals
AC voltage	$V_{pp}$	10	V	between any terminals

**SAW Components**
**K 3350 K**
**IF Filter for Quasi/Split Sound Applications**
**38,90 MHz**
**Data Sheet**
**Characteristics of picture channel**

Reference temperature:  $T_A = 25\text{ °C}$   
 Terminating source impedance:  $Z_S = 50\ \Omega$   
 Terminating load impedance:  $Z_L = 2\text{ k}\Omega \parallel 3\text{ pF}$

		min.	typ.	max.	
<b>Insertion attenuation</b>					
	$\alpha$				
Reference level for the following data	37,40 MHz	13,0	14,5	16,0	dB
<b>Relative attenuation</b>					
	$\alpha_{rel}$				
Picture carrier	38,90 MHz	5,2	6,2	7,2	dB
Color carrier	34,47 MHz	0,4	1,4	2,4	dB
Sound carrier	33,40 MHz	34,0	43,0	—	dB
Adjacent picture carrier	30,90 MHz	45,0	53,0	—	dB
	31,90 MHz	47,0	57,0	—	dB
	31,40 MHz	—	60,0	—	
	32,40 MHz	47,0	55,0	—	
	40,15 MHz	43,0	59,0	—	
Adjacent sound carrier	40,40 MHz	45,0	56,0	—	dB
	41,40 MHz	43,0	55,0	—	dB
Lower sidelobe	25,00 ... 31,90 MHz	39,0	44,0	—	dB
Upper sidelobe	40,40 ... 45,00 MHz	34,0	40,0	—	dB
<b>Reflected wave signal suppression</b>					
1,3 $\mu$ s ... 6,0 $\mu$ s after main pulse (test pulse 250 ns, carrier frequency 37,40 MHz)		42,0	52,0	—	dB
<b>Feedthrough signal suppression</b>					
1,2 $\mu$ s ... 1,1 $\mu$ s before main pulse (test pulse 250 ns, carrier frequency 37,40 MHz)		50,0	56,0	—	dB
<b>Group delay predistortion</b>					
(reference frequency 38,90 MHz)					
	$\Delta\tau$				
	36,90 MHz	—	-90	—	ns
	34,47 MHz	—	30	—	ns
<b>Impedance at 37,40 MHz</b>					
	Input: $Z_{IN} = R_{IN} \parallel C_{IN}$	—	1,1    24,8	—	k $\Omega$    pF
	Output: $Z_{OUT} = R_{OUT} \parallel C_{OUT}$	—	1,6    4,1	—	k $\Omega$    pF
<b>Temperature coefficient of frequency</b>					
	$TC_f$	—	-72	—	ppm/K



SAW Components

K 3350 K

IF Filter for Quasi/Split Sound Applications

38,90 MHz

Data Sheet

Characteristics of sound channel

Reference temperature:  $T_A = 25\text{ °C}$   
 Terminating source impedance:  $Z_S = 50\ \Omega$   
 Terminating load impedance:  $Z_L = 2\text{ k}\Omega \parallel 3\text{ pF}$

		min.	typ.	max.	
<b>Insertion attenuation</b>					
	$\alpha$				
Reference level for the following data	33,40 MHz	12,5	14,0	15,5	dB
<b>Relative attenuation</b>					
	$\alpha_{rel}$				
Sound carrier	33,05 MHz	-1,5	-0,5	0,5	dB
	32,40 MHz	-1,4	-0,4	0,6	dB
Picture carrier	38,90 MHz	41,0	49,0	—	dB
Color carrier	34,47 MHz	28,0	34,0	—	dB
Adjacent picture carrier	30,90 MHz	36,0	43,0	—	dB
Adjacent sound carrier	40,40 MHz	44,0	52,0	—	dB
	41,40 MHz	46,0	56,0	—	dB
Lower sidelobe	25,00 ... 30,90 MHz	36,0	41,0	—	dB
Upper sidelobe	38,90 ... 45,00 MHz	41,0	48,0	—	dB
<b>Impedance</b> at 33,40 MHz					
	Output: $Z_{OUT} = R_{OUT} \parallel C_{OUT}$	—	3,6 $\parallel$ 2,3	—	k $\Omega$ $\parallel$ pF
<b>Temperature coefficient of frequency</b>					
	$TC_f$	—	-72	—	ppm/K



SAW Components

K 3350 K

IF Filter for Quasi/Split Sound Applications

38,90 MHz

Data Sheet

Frequency response of picture channel

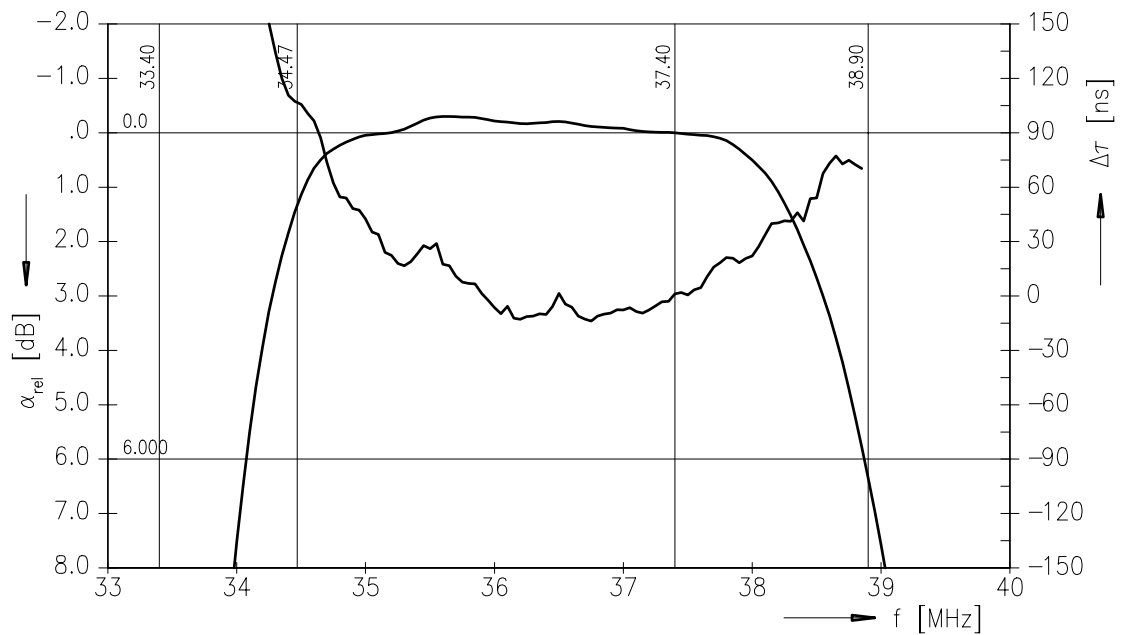
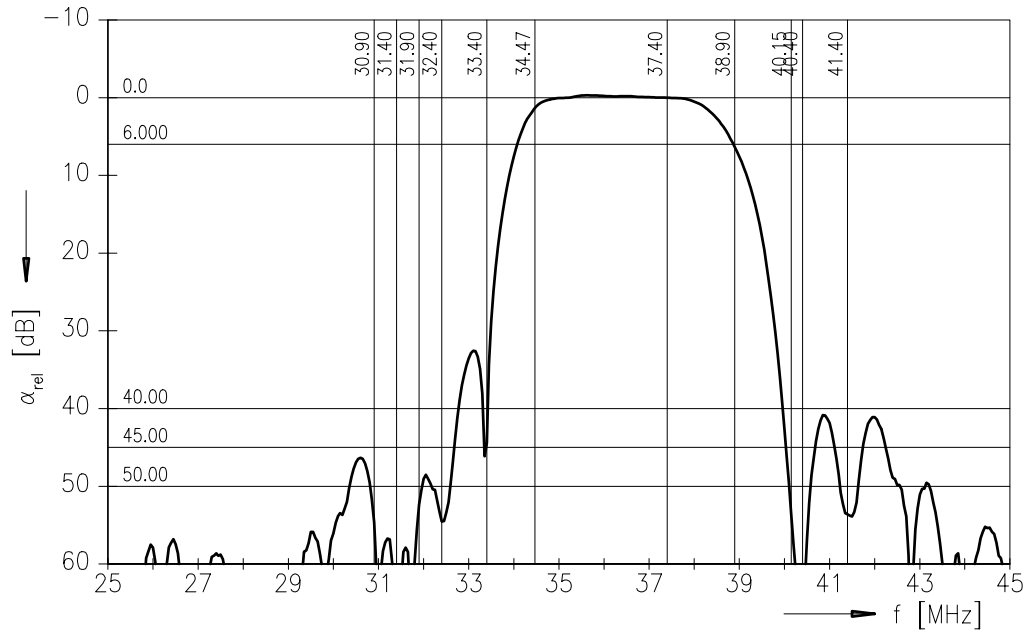



SAW Components

K 3350 K

IF Filter for Quasi/Split Sound Applications

38,90 MHz

Data Sheet

Frequency response of picture channel

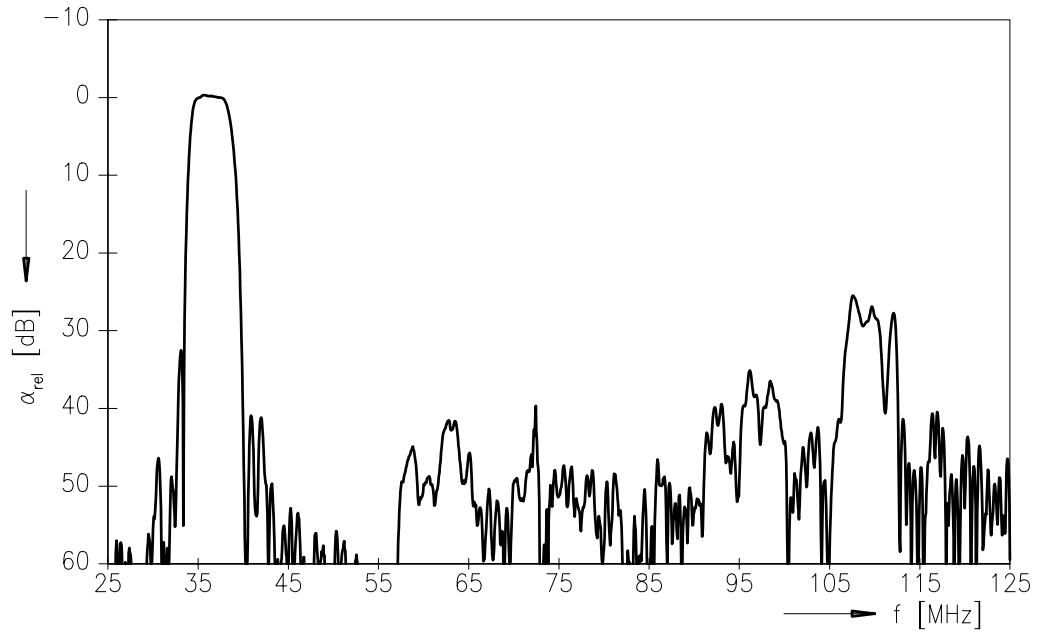

Time domain response of picture channel

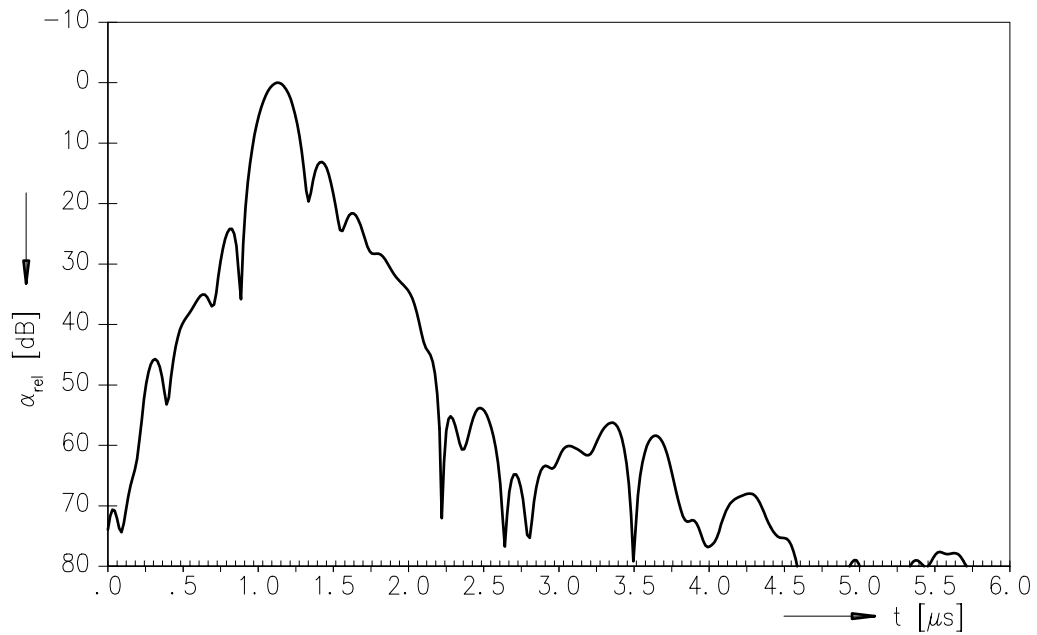



SAW Components

K 3350 K

IF Filter for Quasi/Split Sound Applications

38,90 MHz

Data Sheet

Frequency response of sound channel

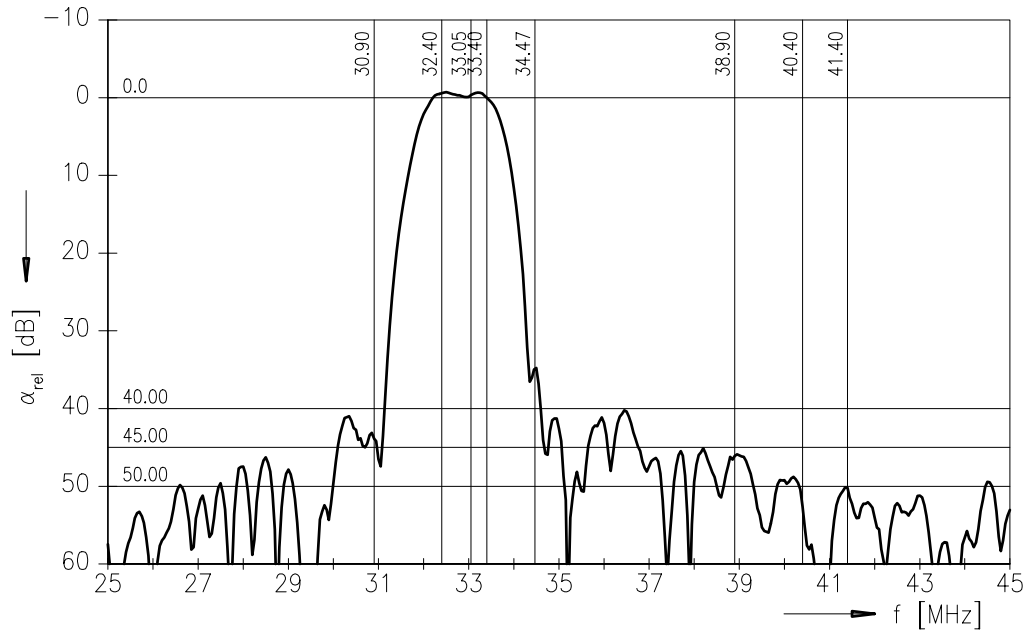



**SAW Components**

**K 3350 K**

**IF Filter for Quasi/Split Sound Applications**

**38,90 MHz**

Data Sheet

**Published by EPCOS AG**

**Surface Acoustic Wave Components Division, SAW CE MM PD**

**P.O. Box 80 17 09, D-81617 München**

© EPCOS AG 2001. All Rights Reserved.

As far as patents or other rights of third parties are concerned, liability is only assumed for components per se, not for applications, processes and circuits implemented within components or assemblies.

The information describes the type of component and shall not be considered as assured characteristics.

Terms of delivery and rights to change design reserved.

For questions on technology, prices and delivery please contact the sales offices of EPCOS AG or the international representatives.

Due to technical requirements components may contain dangerous substances. For information on the type in question please also contact one of our sales offices.